

Technical
Drawing

Desenho
Técnico

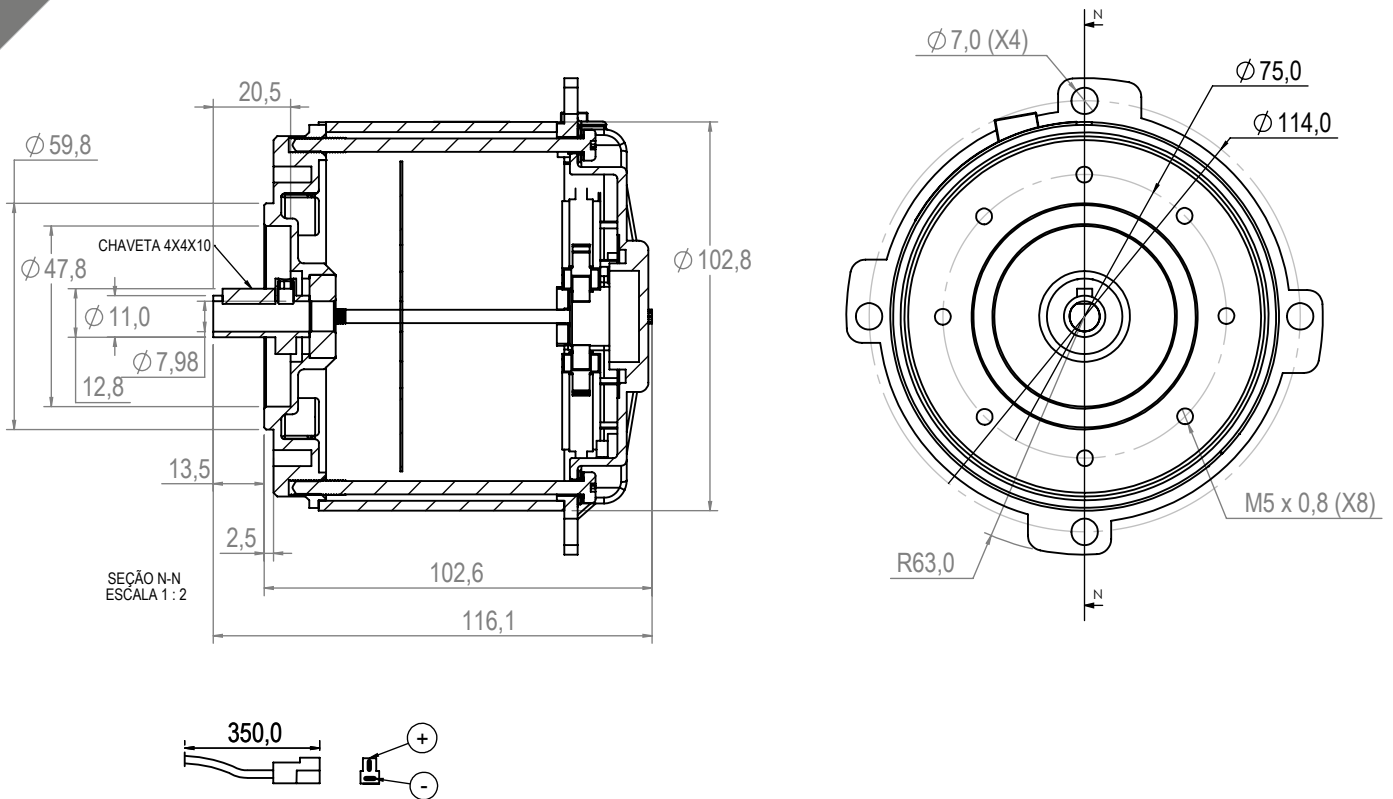

Technical
Specification

Especificação
Técnica

Imagem
Ilustrativa

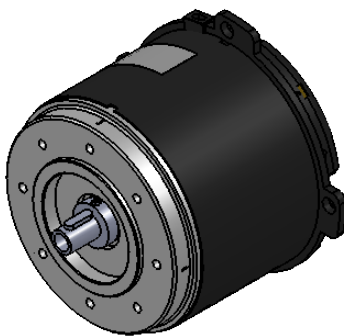

101410512

Valores Nominais	
Tensão (V)	13
Corrente (A)	24
Potência (W)	220
RPM (min ⁻¹)	3000
Torque (N.m)	0,7
Peso (Kg)	2,000

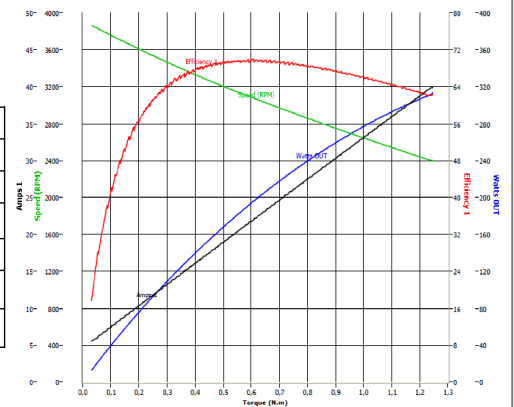

Notas:

-Aplicação: industrial

Notes:

-Application: industrial

101410524

Valores Nominais	
Tensão (V)	27
Corrente (A)	12
Potência (W)	250
RPM (min ⁻¹)	3000
Torque (N.m)	0,8
Peso (Kg)	2,000

